





Prestations électriques:
EN 50393 le cas échéant
le cas échéant

Gel: UL 94-HB 

Température de fonctionnement 

Température de pose: 
-40°C / +50°C

Pour utilisation immergée 

Pour utilisation enterrée 

IP68
OFFICIALLY
TESTED 

Little Joint

Les micro-jonctions IP68 pré-remplies avec du gel, gain de place, dotées de borne et au minimum d'impact esthétique.

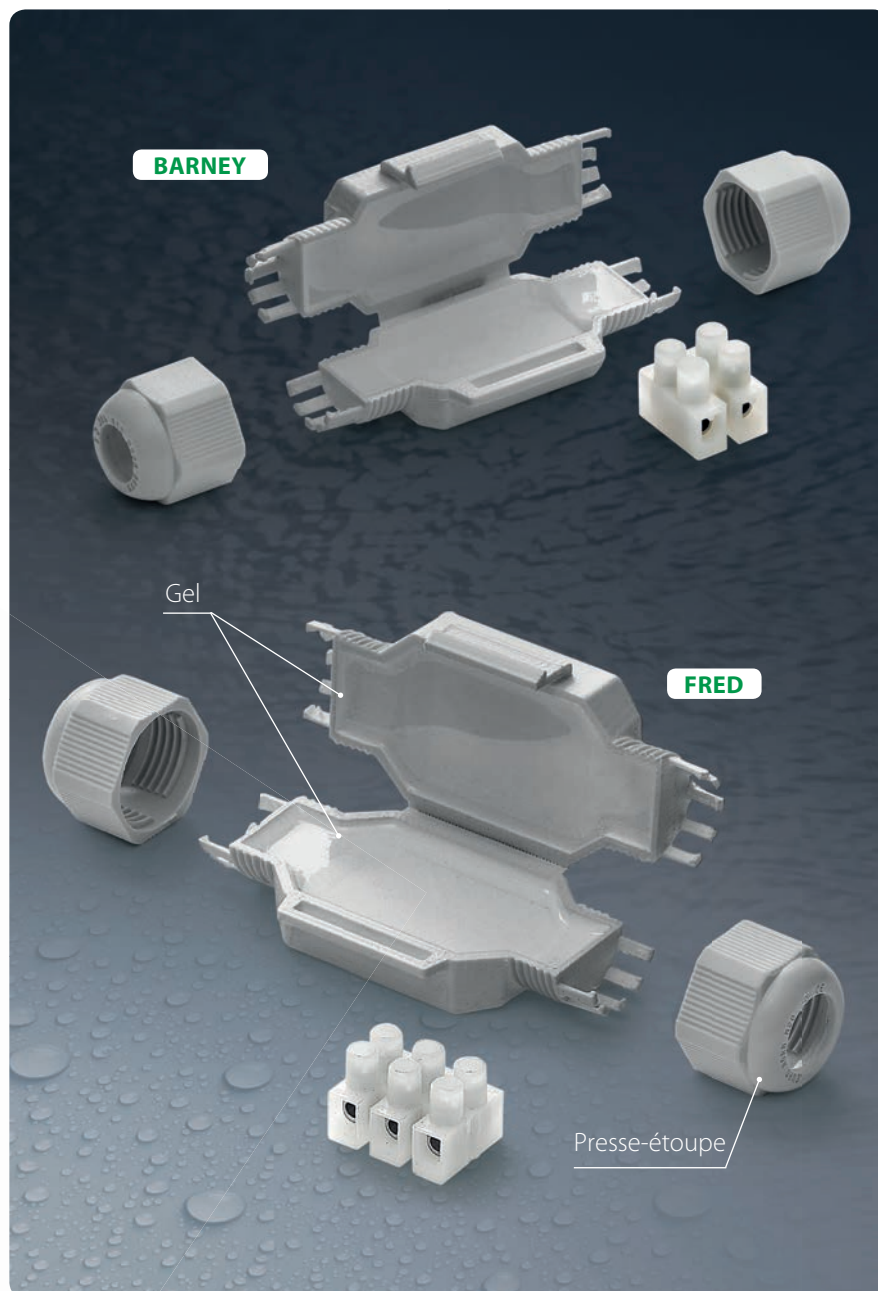



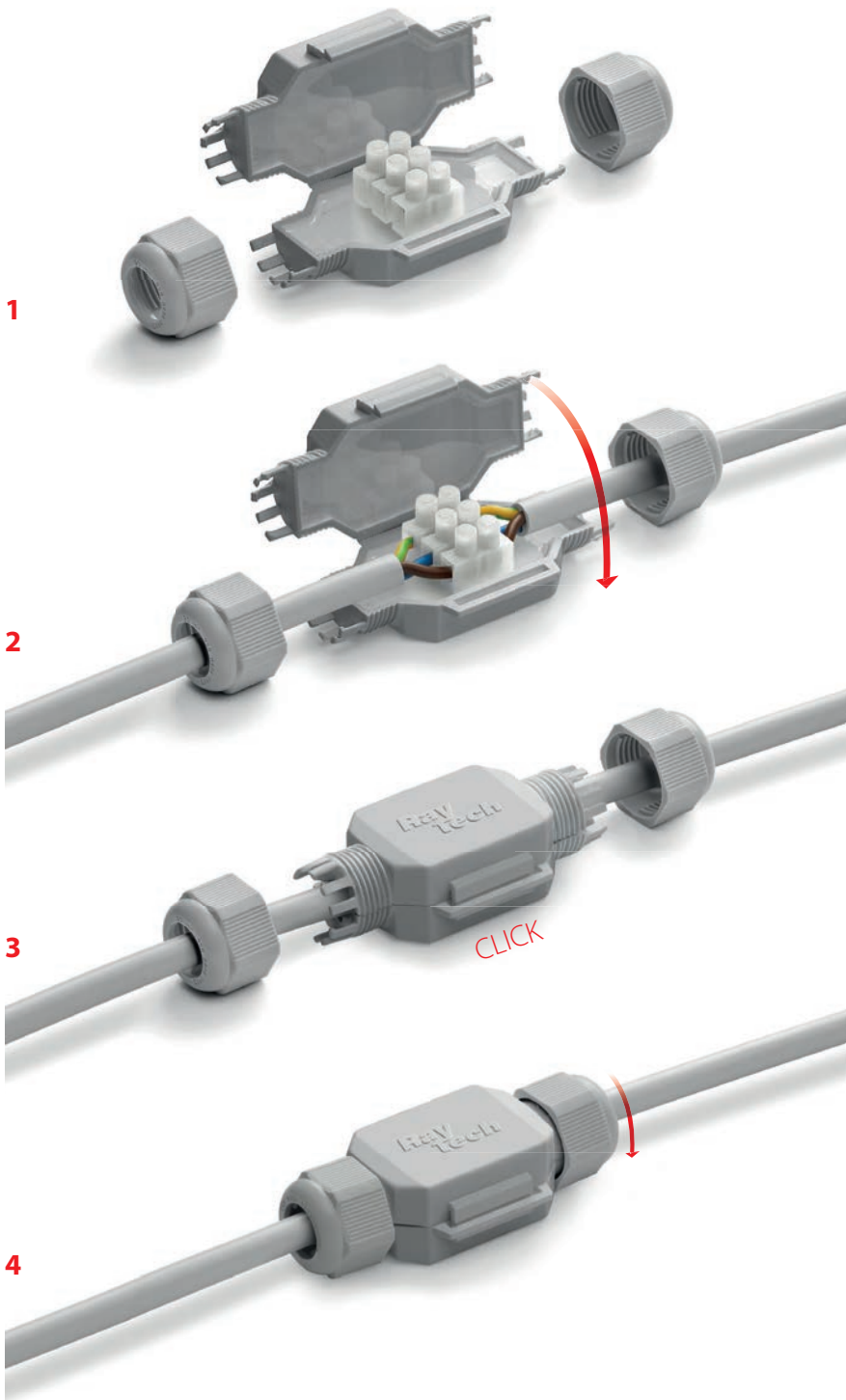

- Dotées de presse-étoupes anti-traction accidentelle du câble
- Dotées de connecteurs à vis
- Pré-remplies en gel atoxique et non classé
- Ultra compactes et prêtes à l'emploi
- Toujours réaccessibles
- Halogen free & UV resistant



Pour des utilisations dans des regards, dans des douilles pour spots à LED, spécialement en présence d'eau et d'humidité, grâce à ses dimensions très réduites.



Produit	Mammut	Formation du câble max (N° x mm ²)	Ø câbles min - max (mm)	Pièces / Pack	 (mm)
Barney		2 x 2,5	6 - 10	1 pz / Blister	75 x 28 x 19
Barney MP				10 pz / Multipack	
Fred		3 x 2,5	8 - 13	1 pz / Blister	80 x 36 x 23
Fred MP				10 pz / Multipack	

