

GALICUBE150

TILT-AND-TURN MECHANISM

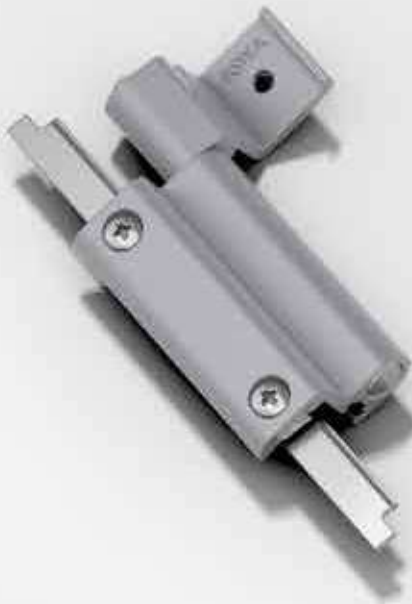

 Made in Italy

fapim[®]
Life in evolution

GALICUBE150

TILT-AND-TURN MECHANISM



10x14.5
12x15
13.6x16.8
14x18



13.6x16.8
14x18

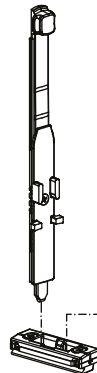
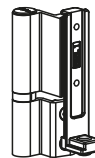
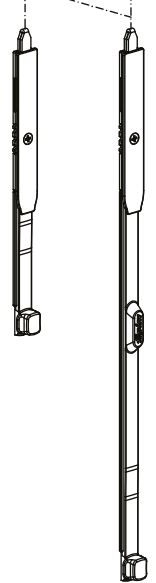
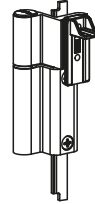
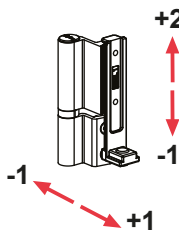
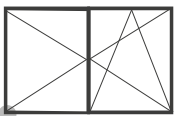
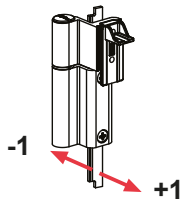
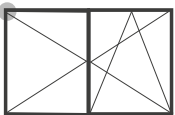
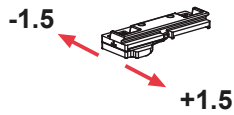
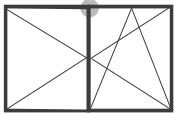
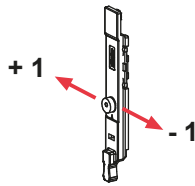
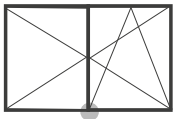
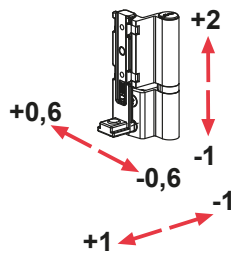
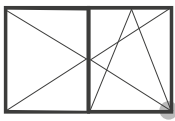
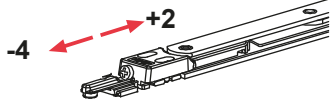
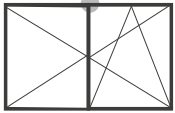

GALICUBE150

TILT-AND-TURN MECHANISM

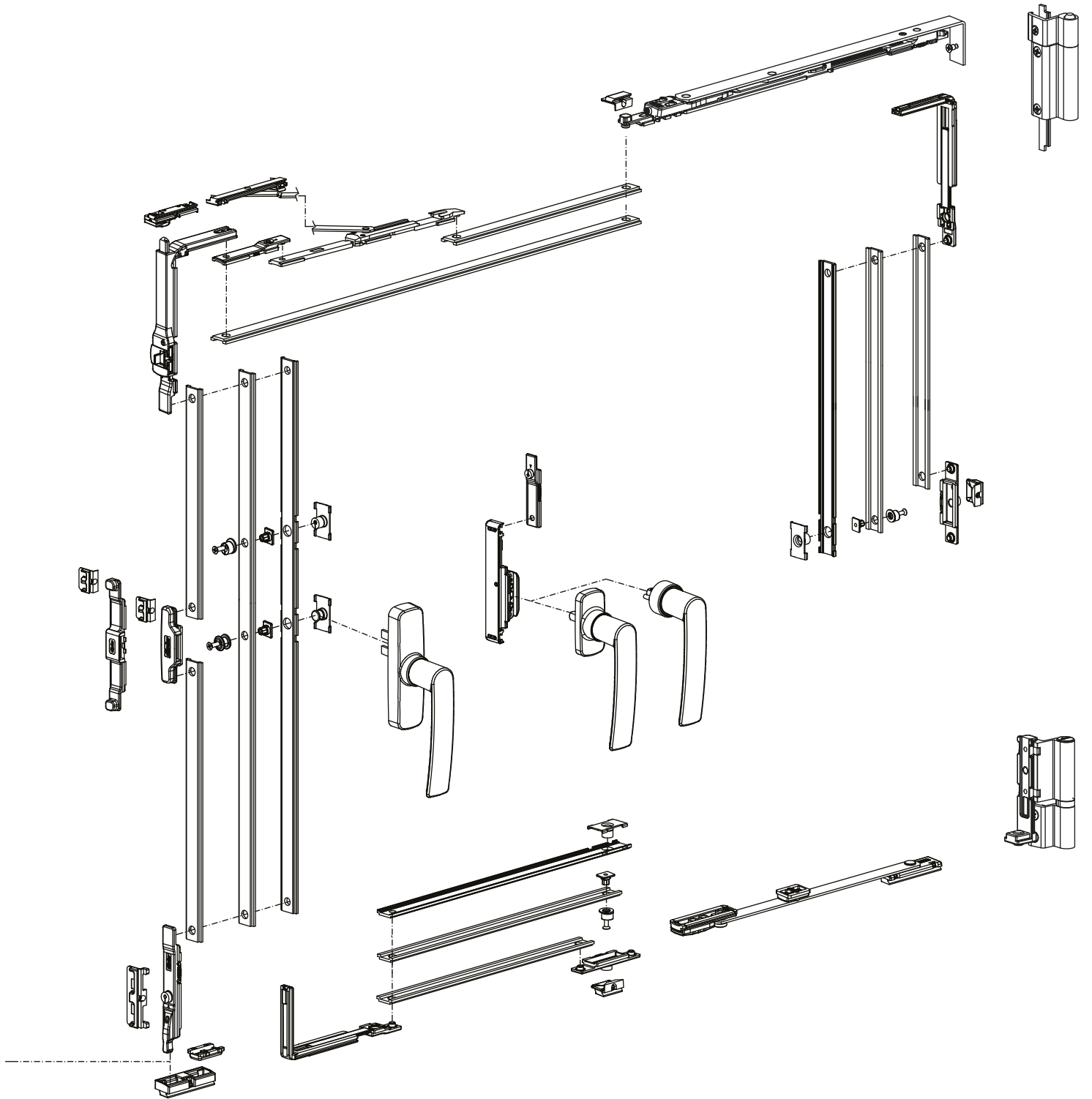
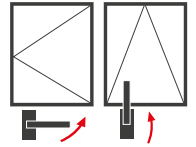

GALICUBE150

TILT-AND-TURN MECHANISM

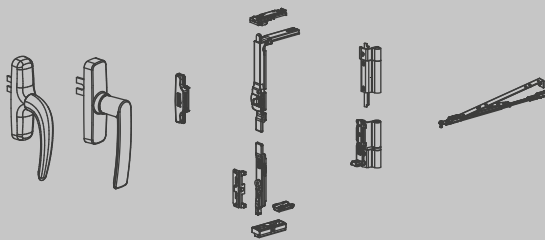

1336AA	0757B									
1336AF		0530B				1447A				
1336BA	0757B		1559A	1461	1410A		10x14.5 12x15 13.6x16.8 14x18		150	1x10
1336BF		0530B				1447B				

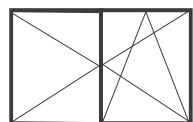

1337FA	0757B									
1337FF		0530B				1447A				
1337GA	0757B		1559A	1462A	1410A 1414A		10x14.5 12x15 13.6x16.8 14x18	13.6x16.8 14x18	150	1x10
1337GF		0530B				1447B				

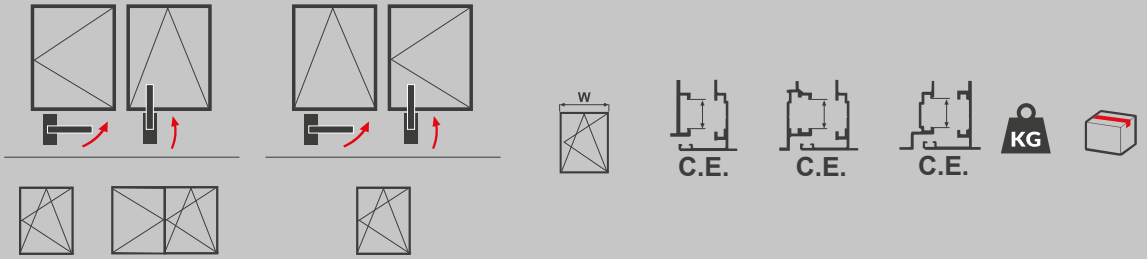

	1410A	●	●	●		10x14.5 12x15 13.6x16.8 14x18			150	10
	1410C	●	●	●				10x14.5 12x15 13.6x16.8 14x18	150	10
	1412A	●	●			10x14.5 12x15 13.6x16.8 14x18			150	10
	1412C	●	●					10x14.5 12x15 13.6x16.8 14x18	150	10
	1414A	●	●			10x14.5 12x15 13.6x16.8 14x18			150	10
	1414C	●	●					10x14.5 12x15 13.6x16.8 14x18	150	10
	1447	●	●		364 ÷ 700					10
	1447A	●	●		402 ÷ 750			10x14.5 12x15		
	1447B	●	●		562 ÷ 1200			13.6x16.8 14x18		10
	1447C	●	●		816 ÷ 1700					10
	1461	●				10x14.5 12x15 13.6x16.8 14x18		10x14.5 12x15 13.6x16.8 14x18		10
	1462A		●				13.6x16.8 14x18			10
	1465A			●	402 ÷ 750					
	1465B			●	562 ÷ 1200	10x14.5 12x15 13.6x16.8 14x18		10x14.5 12x15 13.6x16.8 14x18		10
	1465C			●	816 ÷ 1700					
	1558	●	●							50
	ZM 1559	●	●	●						50
	PA 1559A	●	●	●						
	1563i	●	●	●				10x14.5 12x15 13.6x16.8 14x18		100
	1565i6	●	●	●						100
	1566A	●	●	●						50

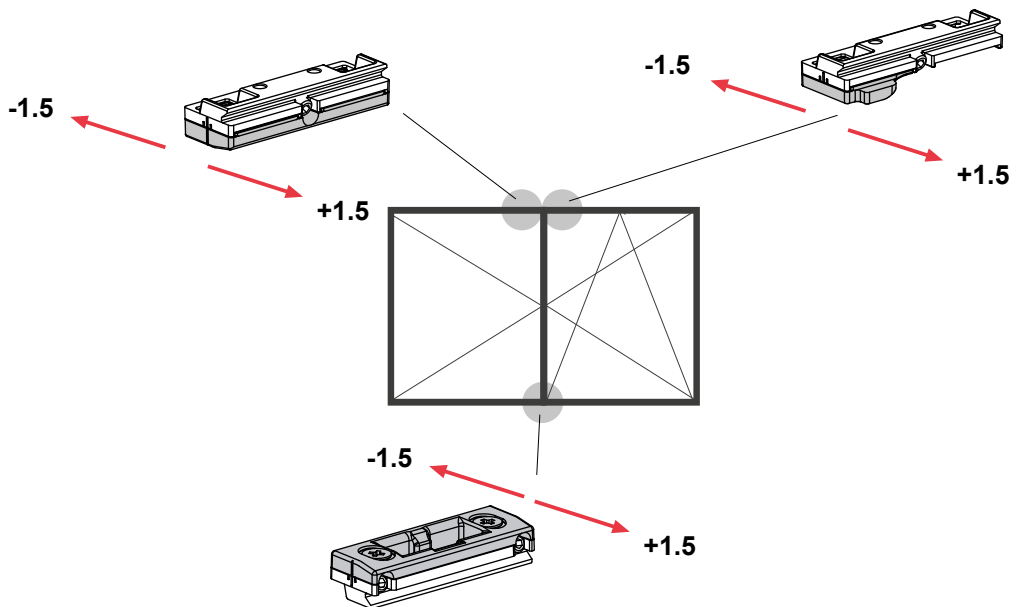
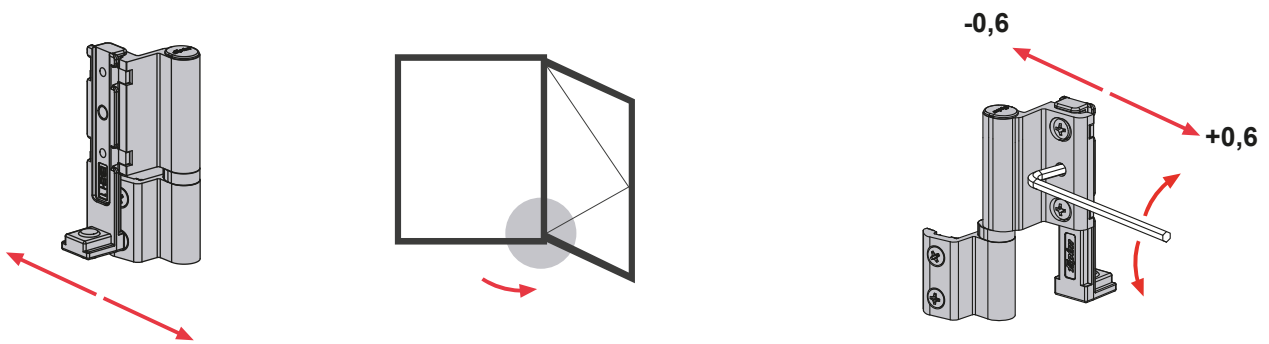
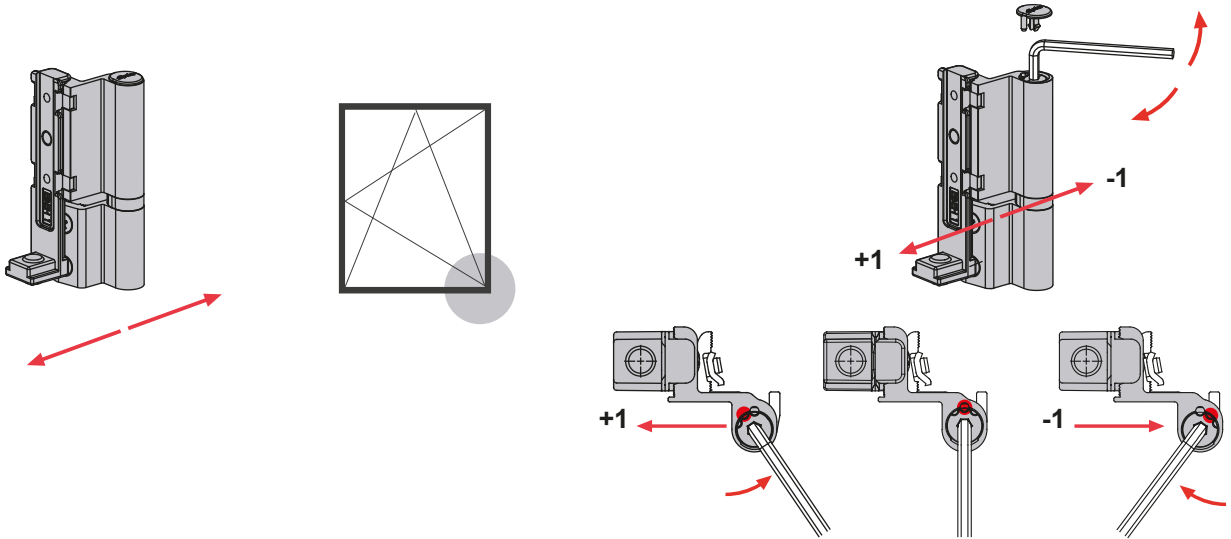
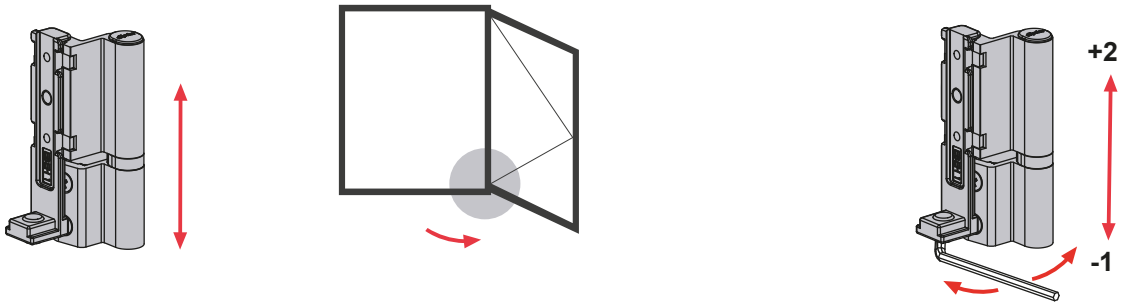

GALICUBE150

TILT-AND-TURN MECHANISM

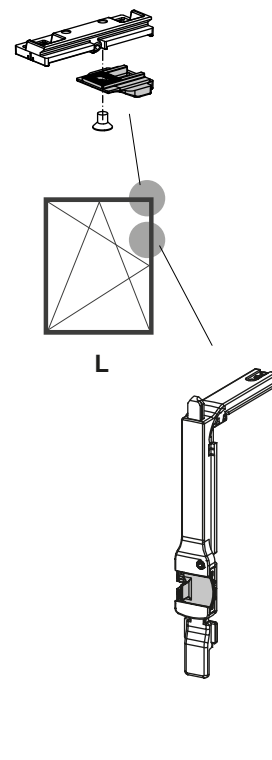
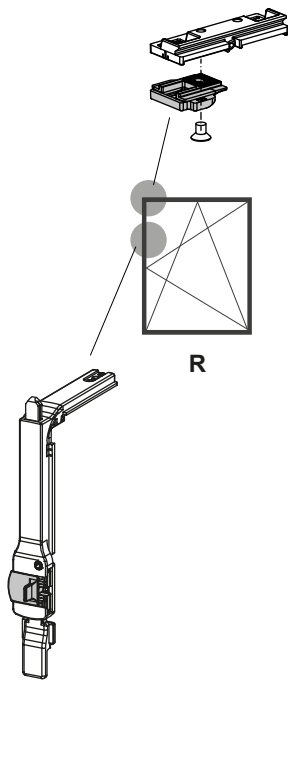
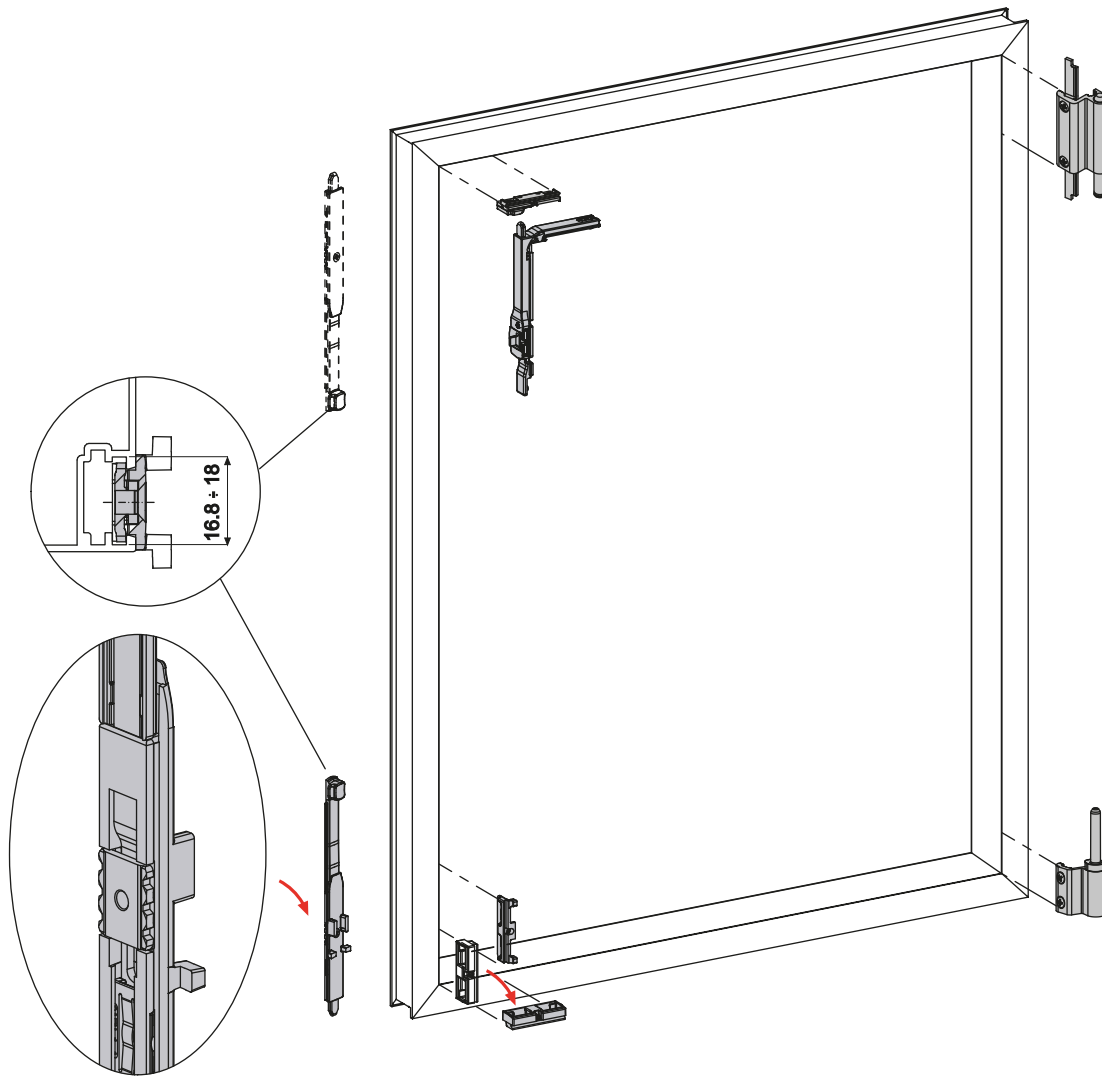

fapim[®]

Fapim S.p.A.
Via delle Cerbaie, 114
55011 Altopascio (LU) Italy
T +39 0583 2601 F +39 0583 25291
www.fapim.it info@fapim.it
Cod.Fisc. e Part.I.V.A. 02224030466

DOMATIC[®]

DOMATIC
info@domatic.it www.domatic.it

fapim

BENELUX

Fapim Benelux s.r.l.
Avenue Rue St. Roch, 17
7712 Herseaux Belgium
T +32 56 340548
T +32 56 341960
info@fapimbenelux.be

fapim

HISPANIA

Fapim Hispania s.L.
C/edison, esq. A. Ingeniero
Goicoechea 45600
Parcela, 74
Talavera De la Reina (Espana)
T +34 925 828357
F +34 925 841148
administración@fapimhispania.com
pedidos@fapimhispania.com

fapim

POLSKA

Fapim Polska sp. z o.o.
ul.Przyrzecze 4 03-107
WarszawaNIP : 536-16-29-437
T +48 227813797
F +48 227811022
Gsm 609022972

fapim

RUSSIA

Fapim RU llc
Kaluzhskaya Region
Province Borovskiy, 99km.
main way "Ukraina", building 4A
T +7 48439 97207
info@fapimru.ru

fapim

ARGENTINA

Fapim Argentina S.A.
CUIT: 30-71206299-8
Calle Gral Alvear N° 411 - 1°
Piso of 1 (B1640EWC) Martinez
Pdo. de San Isidro
Buenos Aires - Argentina
T (+54) (11) 4897-0062
y Líneas Rotativas

